

TECHNICAL CHARACTERISTICS :

Nominal power :	300W
Architecture :	Brushless alternator with direct connection
Output voltage :	3 phase 40V max
Watertightness :	500m
Weight :	7,1kg / 6,3kg
Warranty :	2 years

CRUISING **300W**  
970mm

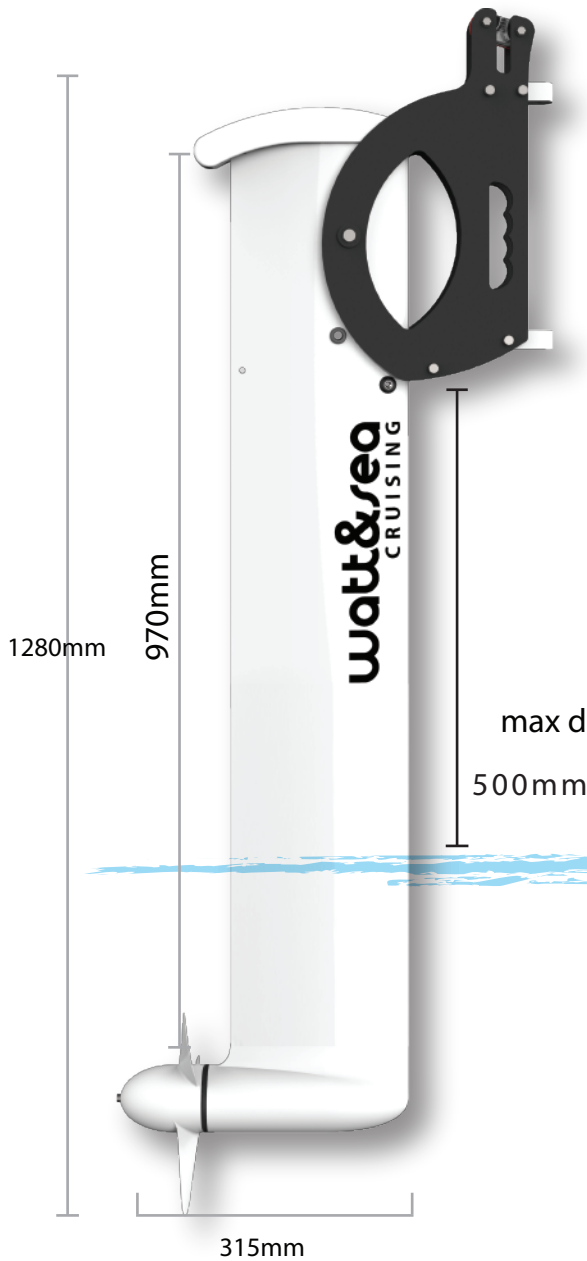

CRUISING **300W**  
610mm

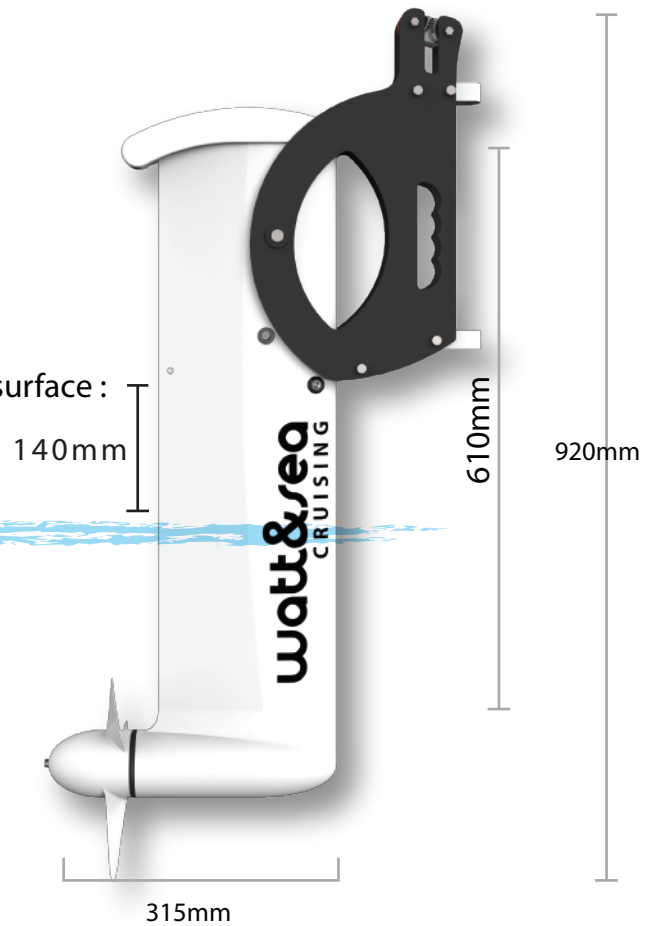

DATE:	NOVEMBRE 2013
TITRE:	Hydogénérateurs CRUISING 300W-970mm / 300W-610mm
DESSIN NON CONTRACTUEL	

**watt&sea®**

L'AUTONOMIE GRÂCE AUX ÉNERGIES RENOUVELABLES

15 rue de la Brigantine - 17000 La Rochelle - FRANCE  
 tél +33(0)5 46 41 31 99 - contact@wattandsea.com - www.wattandsea.com  
 SARL au capital de 231 400€ - Siret : 514 026 467 00019 - NAF : 7112B